



F-801M_J(-C)

Modular Ice Machine Slim-Line Series



F-801M_J(-C)
04/20/18
Item # 13037

Item #: _____
 Project: _____
 Qty: _____
 AIA#: _____

W x D x H
22" x 27^{3/8}" x 26"

F-801MAJ ★
Air-Cooled Flaker

F-801MWJ
Water-Cooled Flaker

F-801MAJ-C ★
Air-Cooled Cubelet

F-801MWJ-C
Water-Cooled Cubelet



Features

- ▶ Durable stainless steel exterior
 - ▶ Advanced CleanCycle24™ design 
 - ▶ Stainless steel auger with greaseless bearing
- Flaker - Up to 751 lbs. of ice production per 24 hours
 - Cubelet - Up to 690 lbs. of ice production per 24 hours
 - Mount two units, side-by-side, in only 44" of floor space for double the amount of ice production
 - 2 second flush cycle every hour
 - Flush cycle removes sediment for cleaner ice
 - Infrared bin control for easy cleaning and reliability
 - R-404A Refrigerant

Available on Bins:

B-250PF B-500PF/SF B-800PF/SF B-1150SS B-1500SS*
B-300PF/SF B-700PF/SF B-900PF/SF B-1300SS B-1650SS*

*Top kit may be required. See Bin Spec Sheets. *Two unit application only.*

Warranty:

3 Year Parts & Labor on entire machine. 5 Year Parts on Compressor; air-cooled condenser coil. Valid in United States, Canada, Puerto Rico and U.S. Territories. Contact factory for warranty in other countries.

ICE PRODUCTION WATER USAGE ELECTRICAL

Condenser	Model	Air / Water Temp Lbs. per 24 hours		WATER USAGE		ELECTRICAL							
		70°/50°F	90°/70°F	Potable Gal. per 100 lbs. 90°/70°F	Condenser Gal. per 100 lbs. 90°/70°F	kWh Used per 100 lbs. 90°/70°F	Max. Fuse Size or HACR Circuit Breaker	Amperage	Voltage	Circuit Wires (including ground)	Heat Rejection BTU/hr.	Refrigerant Charge Amount	Net / Ship Weight (lbs.)
Air	F-801MAJ	751	566	12.0	N/A	4.5	15A	11.8A	115V/60/1	3	5,900	1 lbs. 12 oz.	176 / 205
Water	F-801MWJ	680	605	12.0	119	3.9	15A	11.8A	115V/60/1	3	6,200	10.6 oz.	176 / 205
Air	F-801MAJ-C	690	532	12.0	N/A	5.0	15A	11.8A	115V/60/1	3	5,000	1 lbs. 12 oz.	176 / 205
Water	F-801MWJ-C	632	580	12.0	120	4.13	15A	11.5A	115V/60/1	3	6,000	10.6 oz.	176 / 205

Power cord not included. Must be hard-wired at site.

Cube Dimensions*

Flaked
F-801MAJ

Cubelet
F-801MAJ-C

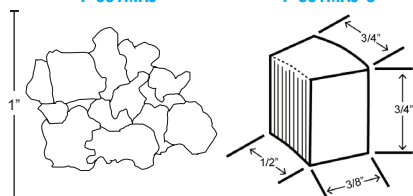

* approximate size in inches, image not to scale

Operating Limits

- Ambient Temp Range 45 - 100°F
- Water Temp Range 45 - 90°F
- Water Pressure 10 - 113 PSIG
- Voltage Range 104-127V

Service

- Panels easily removed and all components accessible for service.
- Removable/cleanable air filter (Air-cooled model only)
- Allow 6" (15 cm) clearance at rear and sides, and 24" (61 cm) clearance at top for proper air circulation and ease of maintenance/service.

Plumbing

- Icemaker Water Supply Line: Minimum 1/4" Nominal ID Copper Water Tubing or Equivalent
 - Icemaker Drain Line: Minimum 3/4" Nominal ID Hard Pipe or Equivalent
- Water-Cooled Model (Lines Must Be Independent of Icemaker)
- Condenser Water Supply Line: Minimum 1/4" Nominal ID Copper Water Tubing or Equivalent
 - Condenser Drain/Return Line: Minimum 1/4" Nominal ID Hard Pipe (open drain system) or Copper Water Tubing (closed loop system) or Equivalent



F-801M_J(-C)

Modular Ice Machine
Slim-Line Series

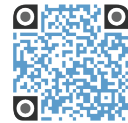

F-801M_J(-C)
04/20/18
Item # 13037

FRONT VIEW

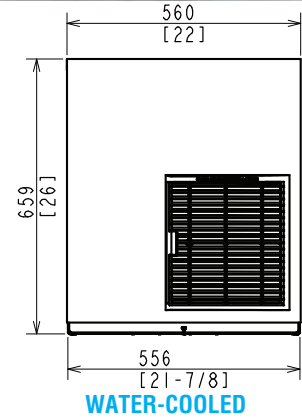
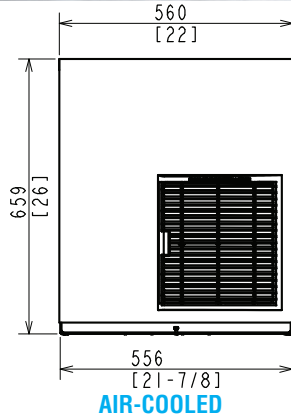

mm
[inch]

SIDE VIEW

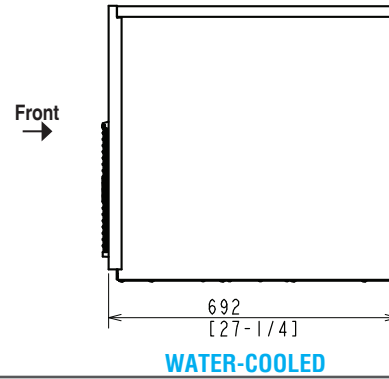
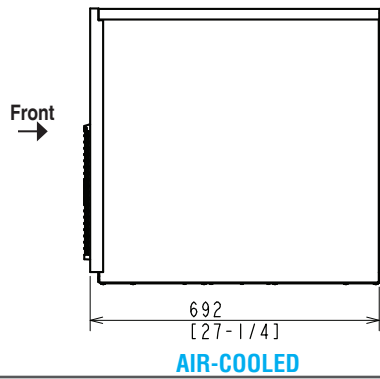

REAR VIEW

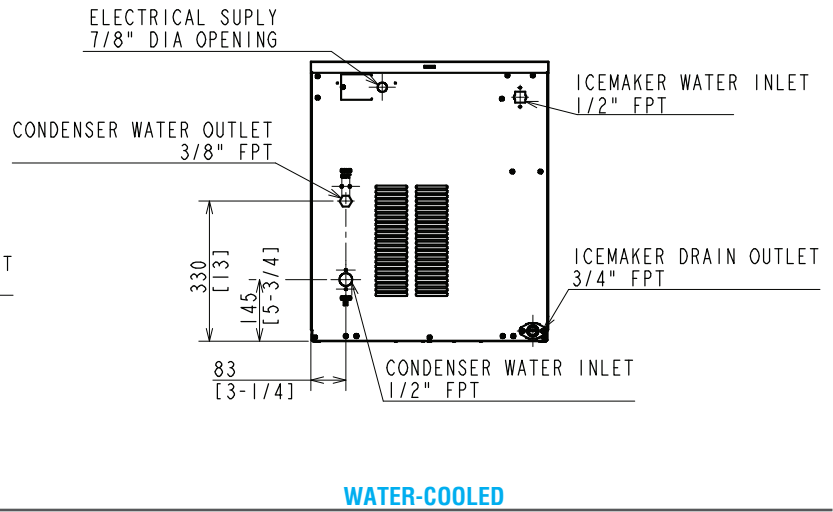
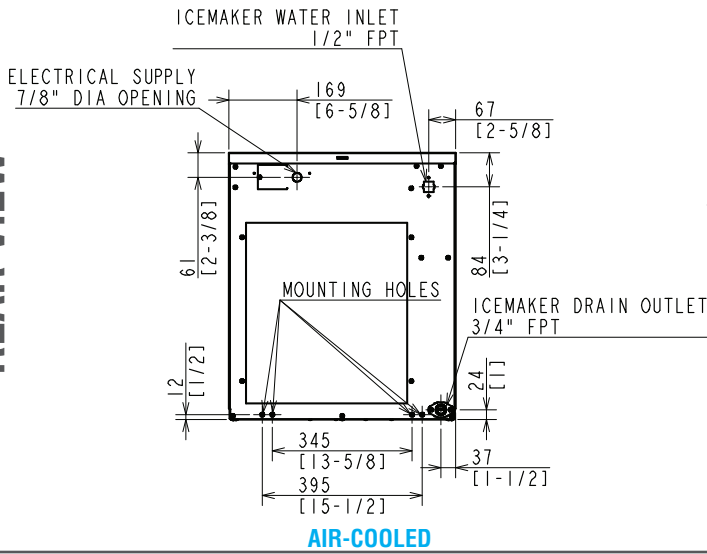

BOTTOM VIEW

